

Computer Science E-7

Exposing Digital Photography

Lecture 4: Exposure (continued)
September 21, 2010

danallan@mit.edu

Shutter Speed

Stopping motion



Photo by Dan Armendariz, 2004
1/1250s, ISO 200, f/2.8



ISO 100

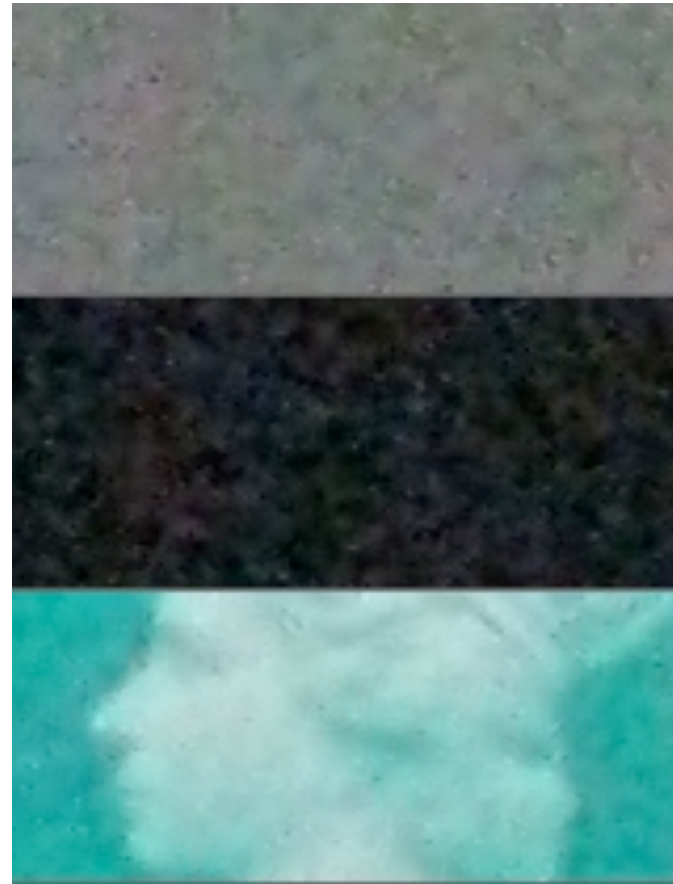

ISO 1600

Images from <http://www.dpreview.com/reviews/canonsx100is/page6.asp>

Sensitivity (ISO)

Compact cameras

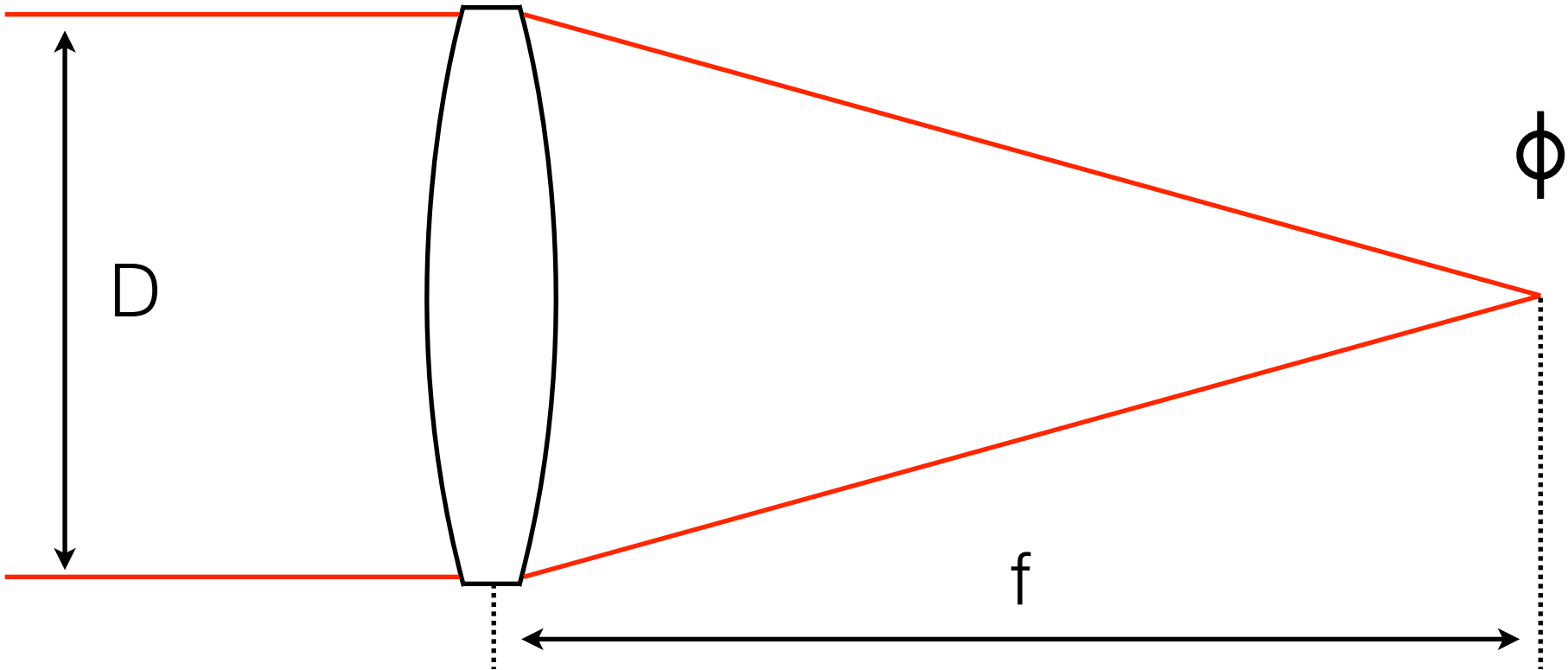

Aperture

F-number = f/D

Exposure

Metering

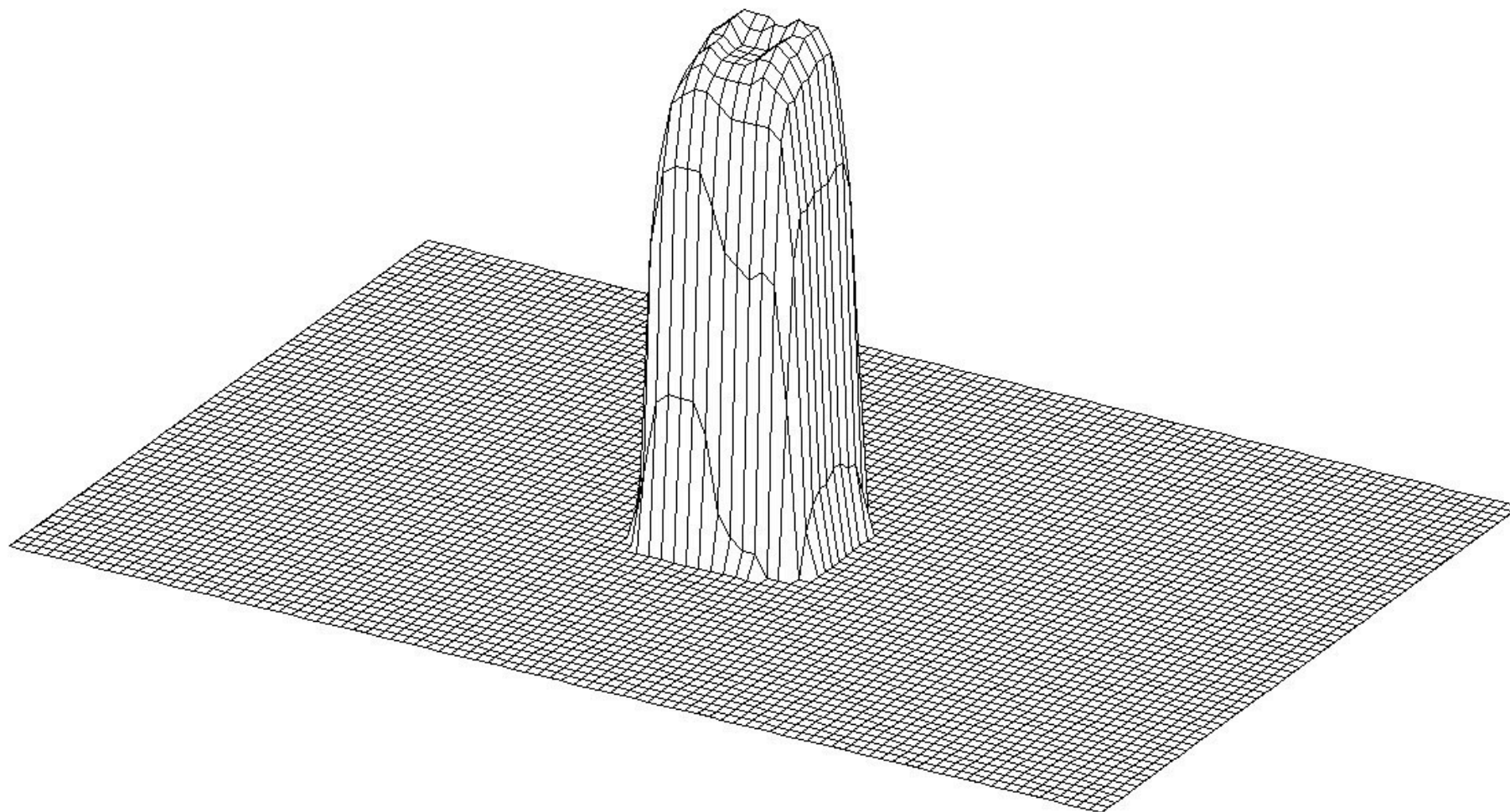

Image from <http://www.imaging-resource.com/PRODS/E40D/E40DA5.HTM>

Metering

Spot

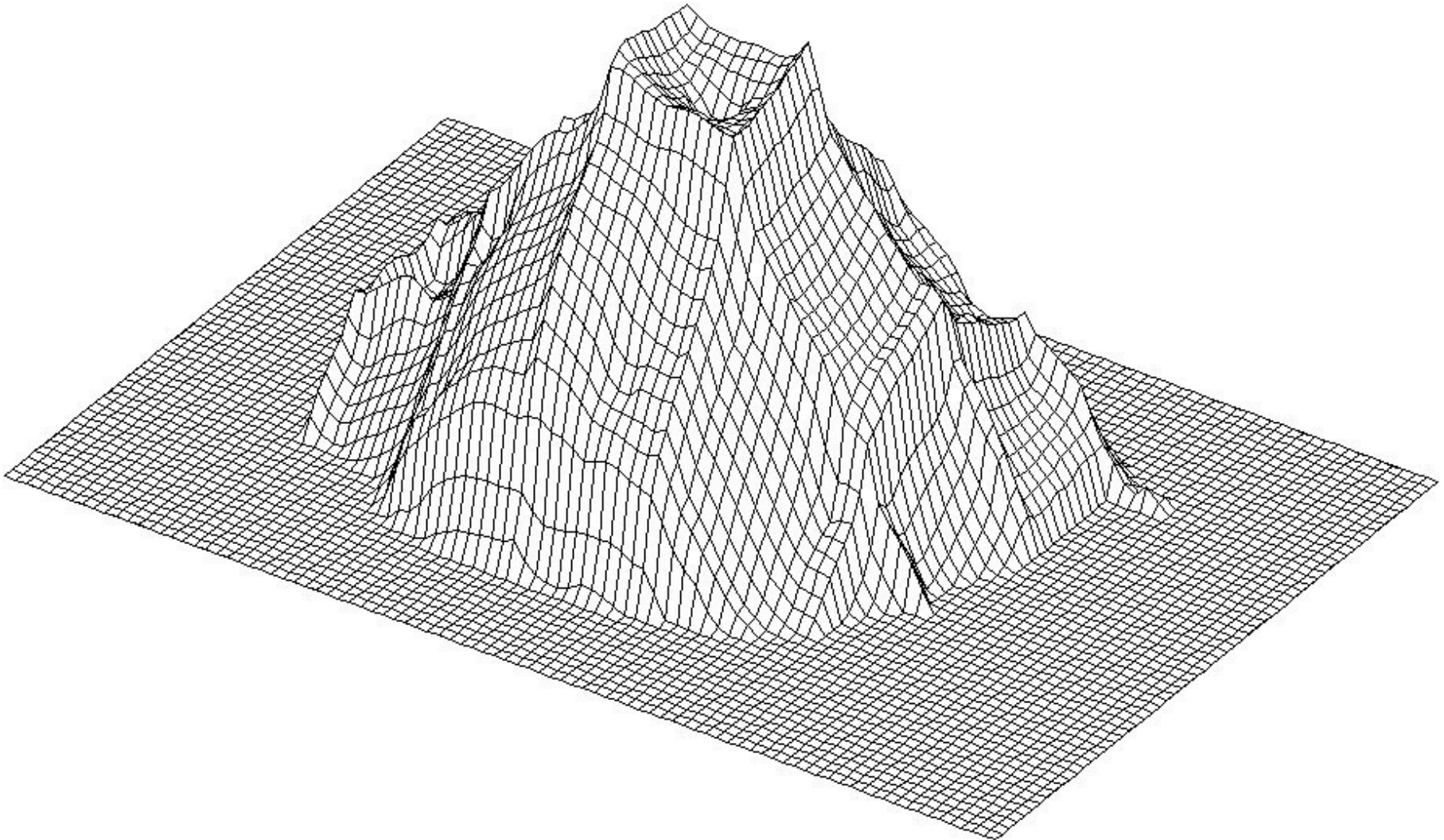

Image from <http://www.imaging-resource.com/PRODS/E40D/E40DA5.HTM>

Metering

Center-weighted



1/2500s, ISO 400, f/5.6

Photo by Dan Armendariz, 2007

Metering

Zone Metering



1/800s, ISO 100, f/4.5, +0.7ev

Photo by Dan Armendariz, 2007

Metering

Exposure Compensation



Left: 1/80s, ISO 400, f/2.8, 0ev. Right: 1/80s, ISO 800, f/2.5, +1.3ev



Photos by Dan Armendariz, 2005

Metering

Positive Exposure Compensation



Left: 611s, ISO 100, f/256, 0ev. Right: 611s, ISO 100, f/256, -2.0ev corrected in software



Photo by Dan Armendariz, 2008

Metering

Negative Exposure Compensation



Image from <http://www.dpreview.com/reviews/nikond40x/page6.asp>

Metering

Camera Modes



Image from <http://www.dpreview.com/reviews/CanonEOS5D/page6.asp>

Metering

Camera Modes

- Amount of available light
- Shutter speed
- Sensitivity (ISO)
- Aperture

Exposure

The Big 4



Left: 1/320s, ISO 800, f/2.5, 0ev Right: 1/40s, ISO 1600, f/3.5, 0ev

Photos by Dan Armendariz, 2005

Exposure

Natural Light



Image from <http://www.dpreview.com/previews/nikond300/page5.asp>

Exposure

Increasing Available Light

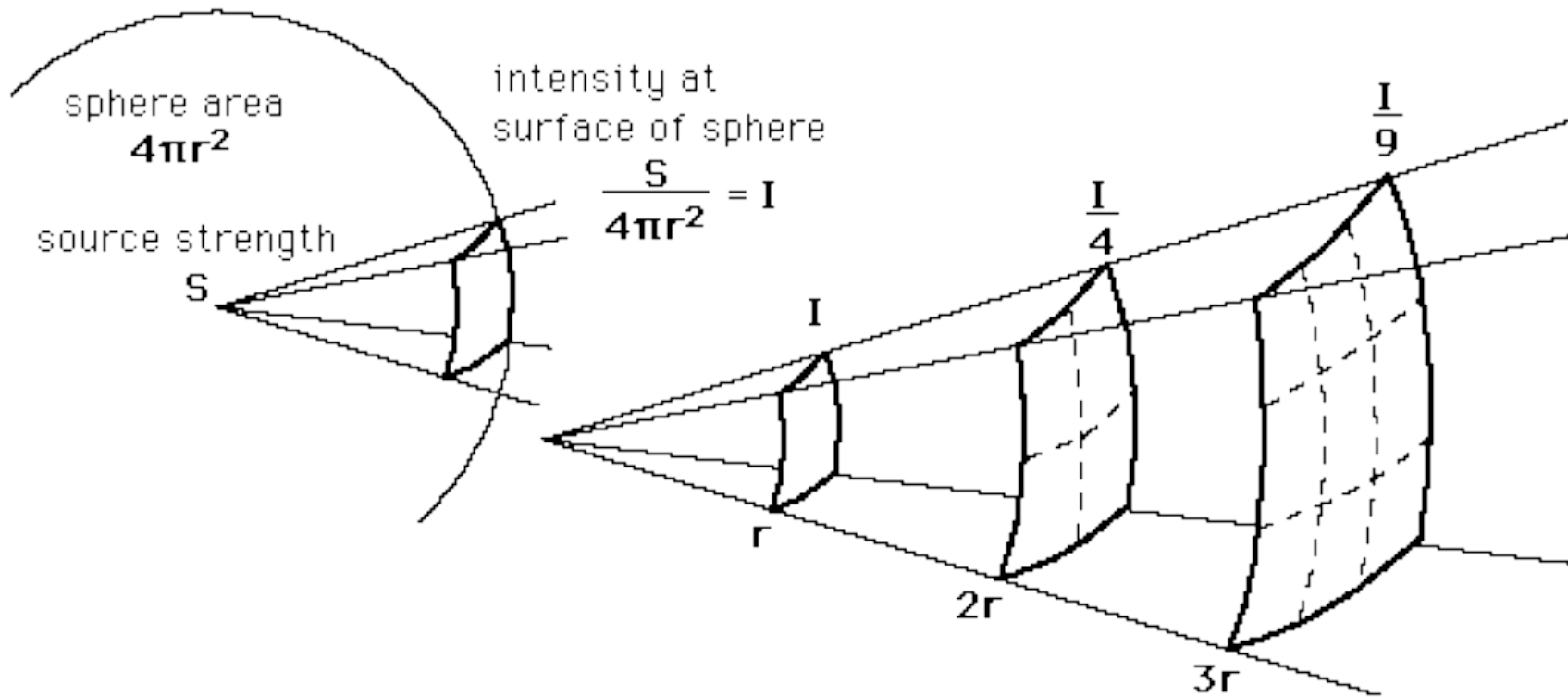

Image from http://imagine.gsfc.nasa.gov/docs/science/try_l2/supernovae.html

Light

Inverse Square Law

Guide Number = Distance x F-number

Flash

Guide Number

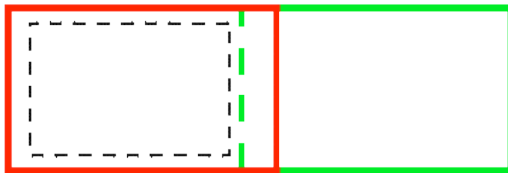

Fig. 1

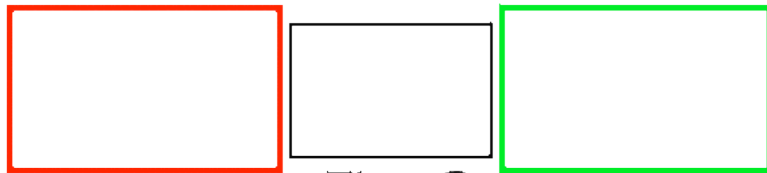

Fig. 2

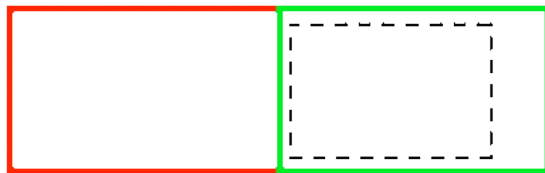

Fig. 3

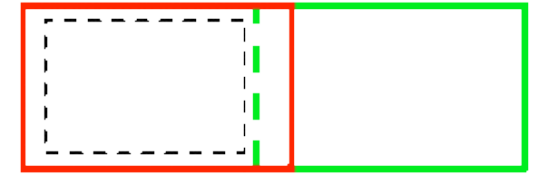

Fig. 1

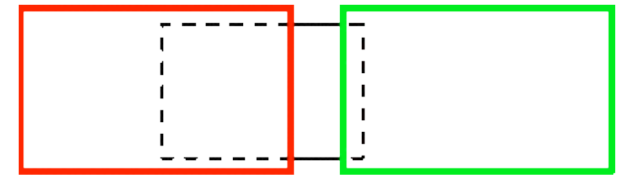

Fig. 2

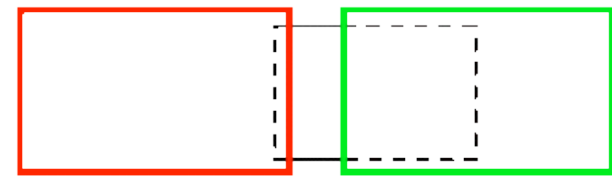

Fig. 3

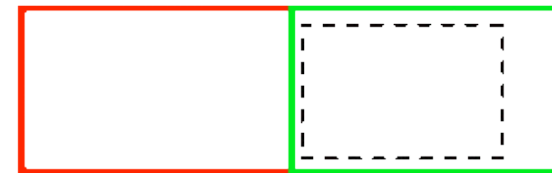

Fig. 4

Left: Slow shutter speed (entire sensor exposed). Right: Fast shutter speed.

Images from http://en.wikipedia.org/wiki/Focal_plane_shutter

Flash

Focal Plane Shutter Re-visited

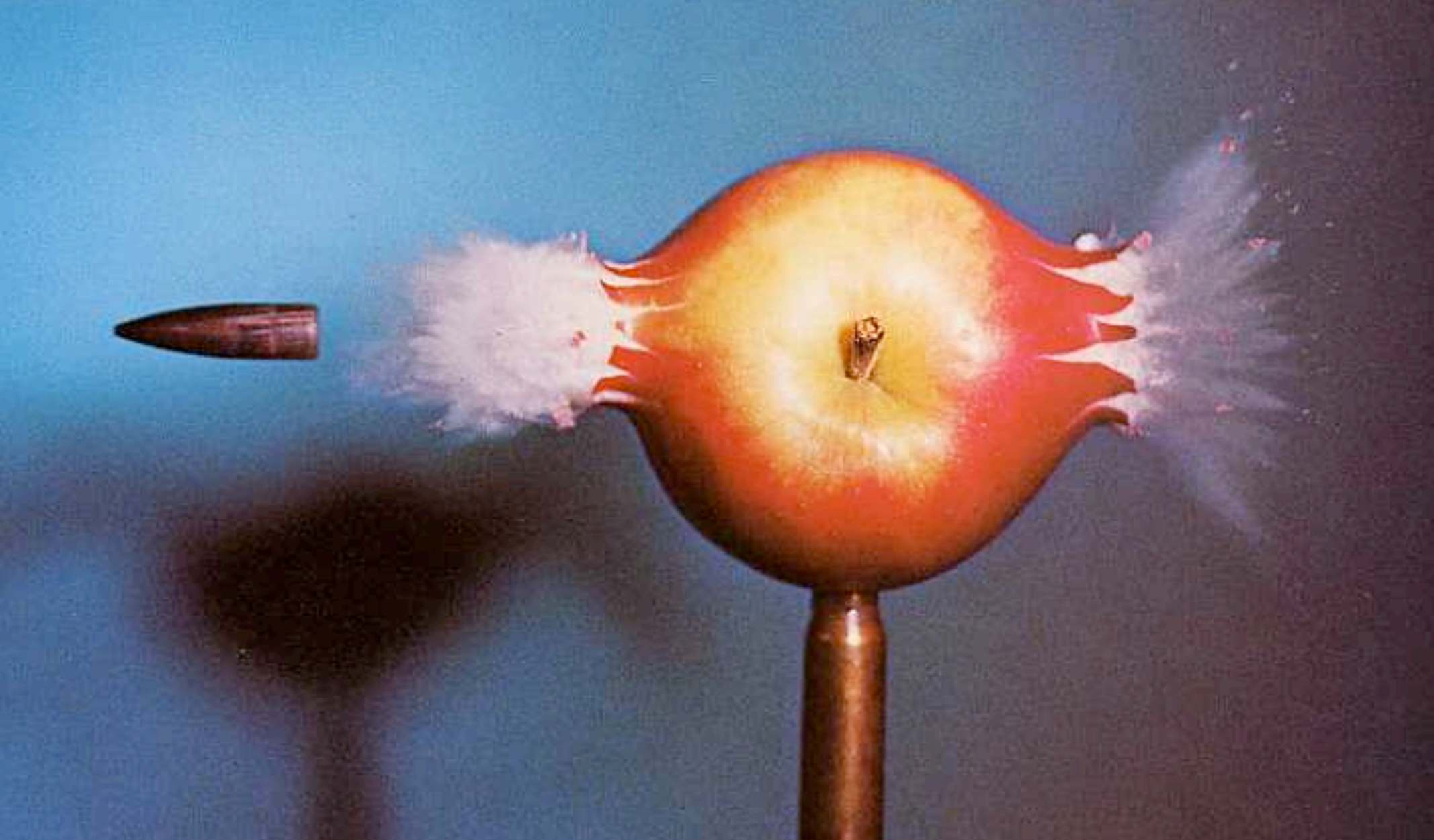

0.30 Bullet Piercing an Apple

©1964, Dr. Harold Eugene Edgerton

Flash

Strobes Are Quick



2s, ISO 100, f/2.8, 0ev

Photo by Dan Armendariz, 2002

When Flash Goes Wrong

Red Eye

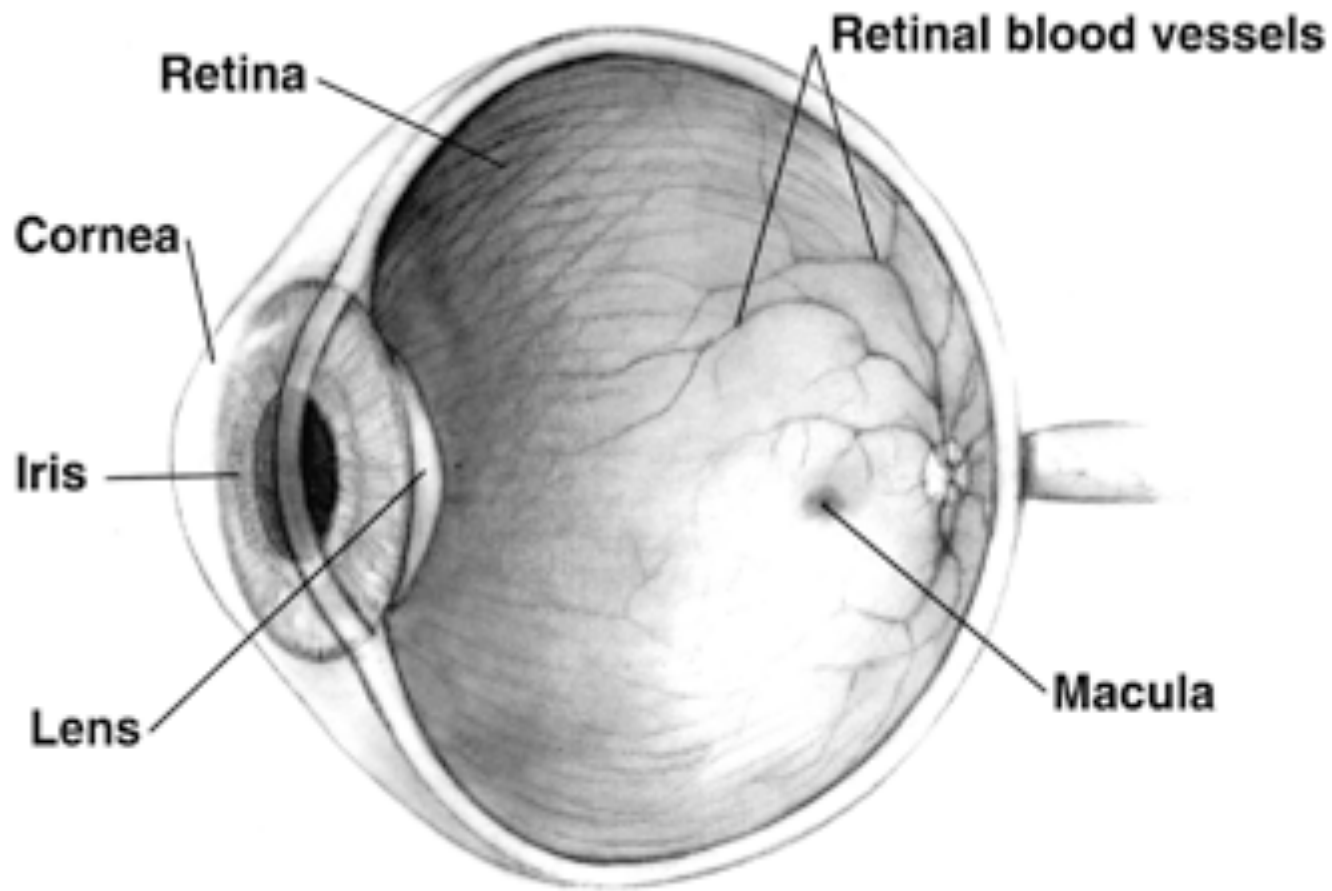

Image from <http://en.wikipedia.org/wiki/Eye>

When Flash Goes Wrong

Red Eye



2s, ISO 100, f/2.8, 0ev

Photo by Dan Armendariz, 2002

When Flash Goes Wrong

Shadows

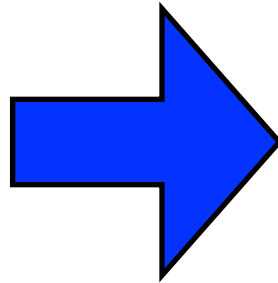

Left image: <http://www.dpreview.com/reviews/CanonEOS30D/page5.asp>, Right image: <http://reallyrightstuff.com/flash/04.html>

When Flash Goes Wrong

Shadows



2s, ISO 100, f/2.8, 0ev

Photo by Dan Armendariz, 2002

When Flash Goes Wrong

Motion Blur



Left: Front-curtain sync. Right: Rear-curtain (2nd curtain) sync

Images from <http://www.nikondigitutor.com/eng/d70/select.php?menu=1&sub=b11&num=4>

Flash

Curtain Sync

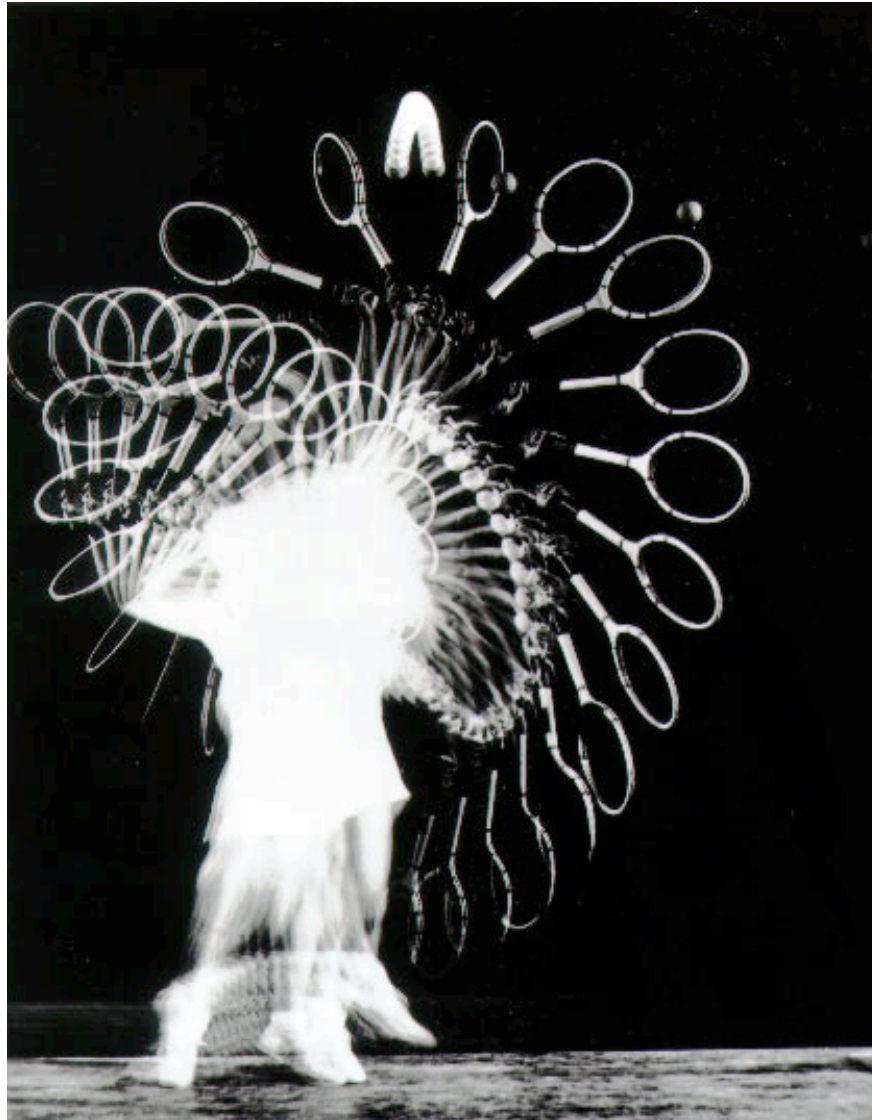

Gussie Moran

©1949, Dr. Harold Eugene Edgerton

Flash

Stroboscopes



Image from <http://www.theothermartintaylor.com/moveabletype/archives/cameras/000156.html>

Flash

Old Flash Units on DSLRs



1/8000s, ISO 1600, f/4.5, 0ev

Photo by Dan Armendariz, 2007

Flash

(Lack of) Fill Flash



1/250s, ISO 100, f/4.5, 0ev

Photo by Dan Armendariz, 2007

Flash

Fill Flash



1/200s, ISO 160, f/5.6, -2/3ev

Photo by Dan Armendariz, 2010

Flash

Fill Flash

Computer Science E-7

Exposing Digital Photography

Lecture 4: Exposure (continued)
September 21, 2010

danallan@mit.edu